



STORAGE AREA NETWORK

Technical Brief: Evaluating Mainframe Networking Options for Long-Distance Data Replication

Reducing the cost and complexity of remote data replication over Wide Area IP Networks.

CONTENTS

Executive Summary	1
Business Continuity and Complex Systems	1
Business Continuity Imperative.....	2
Dealing With Complexity	2
Brocade and Hitachi Data Systems Solutions	2
Mainframe Data Replication Alternatives	3
Remote Replication Software	3
Extending Storage Networks.....	4
Efficient Use of Bandwidth through Compression.....	5
Payload Matching.....	5
Eliminate Unnecessary FC Network Traffic with FastWrite	6
Overcoming Channel Droop with FICON Emulation	6
Case Study 1	7
Around the Clock Customer Service for TIAA-CREF	7
Case Study 2	8
Data Protection and Compliance for a Large Financial Institution.....	8
Effective Long-Distance Data Replication	9

EXECUTIVE SUMMARY

Many of the world's largest organizations rely on mainframe-based applications for core business functionality. For enterprise data center system programmers and storage and database administrators, securing these critical environments against data loss and system outages is a top priority.

Data replication is the business continuity method of choice for mission-critical mainframe applications. But, for the administrators charged with navigating a path between geographically dispersed data centers, the proliferation of products, protocols, and topologies can be daunting. ESCON®, FICON®, legacy bus and tag, Fibre Channel (FC), Storage Area Networks (SANs), and IP and ATM long-distance networks provide a complex mix of interconnectivity that must be overcome for successful long-distance data replication.

Brocade® and Hitachi Data Systems have addressed this business continuity challenge with transformative technologies that mask the complexity of the underlying mainframe IT infrastructure. With support for multiple data center protocols and advanced network and storage virtualization, solutions from Brocade and Hitachi Data Systems can dramatically simplify connectivity between local and remote data centers separated by thousands of miles.

Brocade SAN Routers offer a powerful, high-performance solution for extending ESCON, FICON, bus and tag, and FC connectivity. Using a buffered architecture to bridge IP and ATM Wide Area Networks (WANs), Brocade SAN Routers eliminate storage networking distance limitations to provide high-speed transmission of data between local and remote data centers. Flexible support for multiple protocols enables the platform to mediate long-distance, host-to-storage, and storage-to-storage connectivity. The scalable and sharable Brocade platform enables massive consolidation of intra- and inter-site storage network infrastructures and uses unique emulation techniques to dramatically reduce costs.

Complementing the Brocade platform, Hitachi Data Systems offers mainframe business continuity administrators a wide range of replication options designed to suit the needs of any application environment. Hitachi Compatible Replication for IBM® XRC® uses the IBM XRC command set to support the creation of mainframe-based remote copies on the Hitachi TagmaStore® Universal Storage Platform (USP) and Network Storage Controller (NSC), and on the IBM TotalStorage DS8000 series, DS6000 series, and Enterprise Storage Server—Shark—series storage. A widely-deployed product, Hitachi TrueCopy® Remote Replication software delivers high-speed, high-integrity storage system-based synchronous and asynchronous replication for any heterogeneous storage capable of being attached to the Universal Storage Platform or Network Storage Controller. TrueCopy Remote Replication software also supports IBM's Geographically Dispersed Parallel Sysplex (GDPS), an important consideration for customers who require advanced automation and protection from any lost transactions in the event of a disaster. Other customers may choose the Hitachi Universal Replicator software, which delivers simplified asynchronous data replication across both internal and external storage on the Universal Storage Platform.

Together, Brocade and Hitachi Data Systems provide a high-performance, highly scalable, highly available infrastructure for enterprise mainframe and open systems business continuity.

BUSINESS CONTINUITY AND COMPLEX SYSTEMS

Peer into any modern data center and you will find an enormous variety of infrastructure and application components, the accumulation of many years of IT investments in different technologies. Although each new round of innovation undoubtedly provides benefits at that time, the accumulation of so many diverse protocols, standards, and vendor products weighs heavily on the IT budget and can stifle the flexibility vital to a dynamic IT infrastructure.

For administrators charged with business continuity planning for mainframe applications, the diversity of technologies in the data center is frustrating. Heterogeneous storage systems frequently require vendor-specific replication solutions, resulting in a wide range of different tools to be mastered and supported. Protocol mismatches between mainframe, storage, and local and long-distance networks invariably result in a profusion of unique procedures and processes. And the many networks connecting local and remote data centers, often of different designs and, by necessity, redundant, make transmission of replicated data inefficient and expensive. This accumulated complexity works against providing a flexible, manageable, and cost-effective response to the organization's business continuity needs.

Business Continuity Imperative

As business users increase their reliance on the centralized resources of the data center, the potential cost of an application outage grows. Downtime affects not only business revenue, but also long-term customer satisfaction, ongoing partner relationships, and employee productivity. Business users are now keenly aware of the impact outages have on the organization, and this awareness has generated renewed focus on IT and its vital role in business continuity planning.

For critical mainframe applications, data replication has long been the gold standard of business continuity administrators. Replication technology enables the mirroring of production data to a remote location, where it can be accessed at a moment's notice if local connectivity is disrupted. Using data replication as part of a comprehensive business continuity plan also allows administrators to perform data center upgrades without disrupting end-user access to applications. Rather than schedule downtime, administrators can switch access to remote copies of the production data while local upgrades are performed. This gives business users, customers, and partners continuous access to critical business systems.

Dealing With Complexity

In complex data center environments, protocol and technology mismatches frequently compound connectivity and manageability problems, undermining efforts to provide continuous availability of business applications. But this does not have to be the case. Technologies that leverage IT infrastructure heterogeneity, without degrading performance, scalability, or access to functionality, can transform the data center by lowering costs, raising productivity, and improving flexibility.

The combination of support for multiple protocols and virtualization technology is key to combating data center complexity. When technical resources are virtualized, individual differences between vendor implementations and protocols are masked by a single, seamless interface. Virtualization allows heterogeneous resources to be pooled. This leads to more efficient and flexible resource allocation and more productive management.

When evaluating mainframe business continuity, consider Brocade and Hitachi Data Systems, which deliver multiprotocol support and virtualization technologies that simplify the storage and storage network infrastructure and improve business continuity configuration flexibility.

BROCADE AND HITACHI DATA SYSTEMS SOLUTIONS

The Hitachi TagmaStore Universal Storage Platform is a high-performance, highly scalable, and highly available storage system. The Universal Storage Platform, and its midrange counterpart the Hitachi TagmaStore NetworkStorage Controller, support an innovative, controller-based virtualization engine. Virtualization allows third-party storage devices to appear to applications and administrators as internal capacity of the Hitachi storage system, enabling an otherwise heterogeneous group of dissimilar systems to respond as single contiguous pool of capacity.

The Hitachi storage systems also support a wide range of protocol connectivity options, including ESCON, FICON, and FC. This combination of multiprotocol support and virtualization dramatically simplifies the storage infrastructure, lowering the total cost of storage ownership and increasing infrastructure flexibility.

Brocade SAN Routers offer a wide range of multiprotocol connectivity, with advanced network and bandwidth management capabilities that support consolidation and pooling of network bandwidth. Brocade SAN Routers allow administrators to pool the capacity of multiple Ethernet and ATM long-distance networks so that storage applications simply see one large pipe between local and remote data centers, allowing the Brocade platform to be a key network component enabling full Hitachi functionality.

Support for multiple storage networking protocols and massive scalability provides administrators the flexibility to consolidate workloads from many existing storage networking and long-haul connectivity components on a single infrastructure device. The Brocade platform supports the intermix of FICON and FC protocols, allowing mainframe and open systems networks to be consolidated. This protocol flexibility dramatically simplifies the storage network infrastructure and delivers management and provisioning efficiencies that reduce capital and operating costs.

The Hitachi storage systems and Brocade storage networking platforms provide the core infrastructure for an enterprise business continuity configuration based on long-distance data replication. Using replication software from Hitachi Data Systems, mainframe administrators can effectively secure critical data against loss and speed application recovery after a failure.

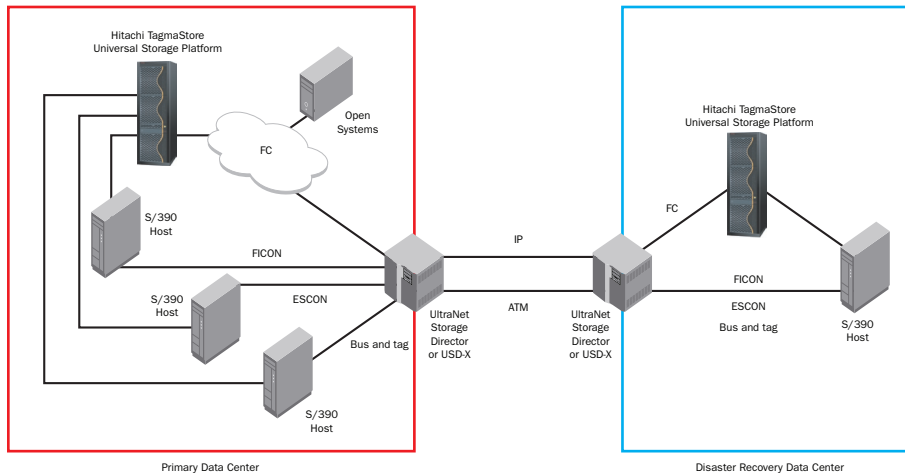

Figure 1. Topology of a Brocade and Hitachi Data Systems storage networking configuration

MAINFRAME DATA REPLICATION ALTERNATIVES

The multiprotocol connectivity and virtual pooling capabilities of joint Brocade-Hitachi Data Systems solutions provide administrators with significant flexibility when configuring long-distance data replication. Solutions from Hitachi Data Systems support mainframe-based data replication over routed or extended ESCON or FICON connections, and direct storage system controller-based replication over Brocade extended FC networks.

REMOTE REPLICATION SOFTWARE

Hitachi Data Systems offers multiple data replication solutions appropriate to mainframe applications in the enterprise data center. Hitachi TrueCopy Remote Replication software is an innovative, storage-based replication solution that operates on the Hitachi high-end and mid-range storage systems. Remote replication software provides synchronous and asynchronous data replication capabilities, allowing redundant copies of critical data to be used for rapid recovery of business applications after an outage.

Operating on all new and legacy Hitachi storage systems, remote replication software performs replication at the storage system controller, eliminating processing overhead from the application host server. The local and remote replication volumes do not have to be of the same disk type or even the same type of RAID configuration. For example, primary volumes in the main data center can be high-speed FC devices with a RAID configuration tuned for performance, and secondary volumes at the remote data center can be cost-effective storage with SATA drives and RAID optimized for efficient use of capacity.

Another option, Hitachi Universal Replicator software, delivers simplified asynchronous data replication across both Universal Storage Platform internal and external storage. For organizations that have demanding heterogeneous data replication needs for business continuity or improved IT operations, Universal Replicator provides the enterprise-class performance associated with storage-system-based replication while providing truly resilient business continuity without need for redundant servers or replication appliances.

Universal Replicator software's significant advantage over competitive products is derived from advanced technology designed to fully leverage USP capabilities including disk-based journaling, lower cache utilization, better bandwidth control, and link failure mitigation. Multi-data center support, including workload management to reduce resource usage on the production/primary system, enables full leverage of the Universal Storage Platform's capabilities.

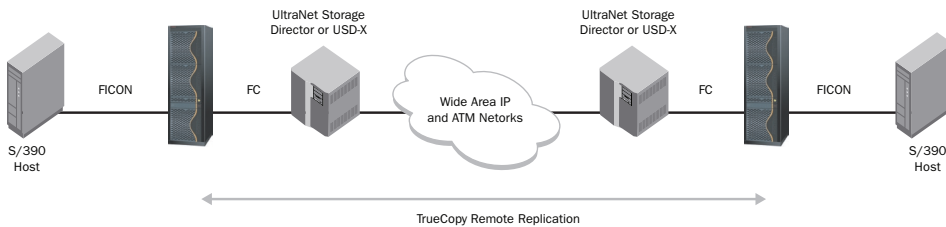

Figure 2. Hitachi TrueCopy Remote Replication software over Brocade extended FC network

For enterprise users familiar with mainframe-based data replication, the Hitachi Compatible Replication software for IBM XRC has long provided a tried-and-tested method of securely moving large amounts of application data between data centers. Unlike Remote Replication software, Compatible Replication software for XRC runs on the remote mainframe server and relies on a channel-extended ESCON or FICON connection to the local storage system to carry replication traffic.

Whether replicating across FC connectivity between local and remote storage systems or channel-extended ESCON or FICON to access a local storage system from a remote data center, the efficient bridging of long distance Ethernet and ATM networks connecting the two replication sites is critical to the success of business continuity implementations.

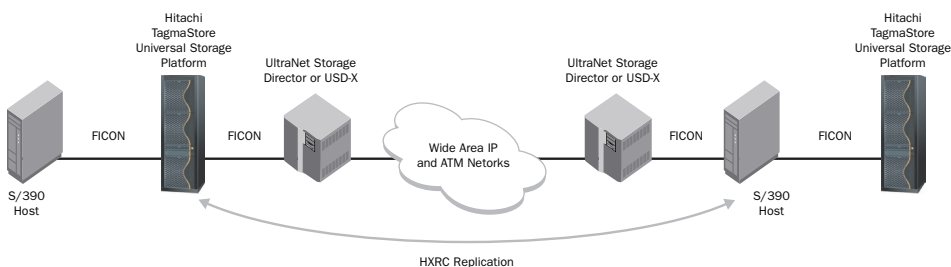

Figure 3. Hitachi Compatible Replication software for IBM XRC over Brocade extended FICON network

EXTENDING STORAGE NETWORKS

Traditional ESCON and FICON storage networking protocol connections are limited to 3 km and 20 km respectively. For many organizations, these distances are not sufficient when attempting to replicate critical business application data out of harm's way. The Brocade platform provides a gateway for host-to-storage and storage-to-storage connectivity across Ethernet- and ATM-based long distance networks spanning thousands of miles. Using cascading connectivity that allows ESCON-, FICON-, and FC-connected storage and hosts to bridge Ethernet and ATM networks, the Brocade platform eliminates protocol distance limitations faced by solutions from other storage networking vendors.

A key differentiator is that the Brocade platform supports the intermix of FICON and FC storage traffic on the same device. This enables mainframe and open systems storage applications—such as data replication, backup, extended disk and tape, data migration and content distribution, shared storage, and peripheral and channel-to-channel extension—to share the same extended networking infrastructure. The FICON and FC intermix capability provides a single pool of shared resources allowing the cost-effective consolidation of mainframe and open systems storage networking environments.

Fast I/O throughput is essential to successful data replication, with synchronous data replication techniques especially sensitive to network speed and quality. Any latency in transmitting data between one location and another is telegraphed back to business applications as degraded performance. The Brocade platform provides low-latency, high-throughput connectivity to maximize replication IOPs and minimize application delays. A wide range of dynamically tunable configuration options help to minimize latency and maintain wire-speed communication at all times.

The Brocade SAN Router platform uniquely enables mainframe distance replication through the use of data compression, payload matching, FastWrite, and FICON Emulation features, the ease of which will be addressed in the next sections of this paper.

EFFICIENT USE OF BANDWIDTH THROUGH COMPRESSION

Applying compression to the data traveling across a network reduces traffic and optimizes the use of available bandwidth. The Brocade platform uses configurable intelligent compression routines to dynamically optimize throughput and ensure the fastest communication possible between two end-points in a network.

As data streams pass through the intelligent ports of the Brocade platform, compression routines analyze the traffic for repetitive patterns. When the platform is configured for automatic analysis, the amount of data compression applied is transparently and incrementally adjusted to allow the data rate at the exit port to be optimized. For example, if uncompressed data is arriving at 65 Mbit/sec and the port speed of the exit port is set for T3 (approximately 45 Mbit/sec), the data stream will be compressed just enough to ensure the maximum T3 speeds are maintained. An alternative compress-always mode ensures minimum possible bandwidth is used; this option has been designed for use with dedicated and shared network infrastructures.

The compression method is configured by the administrator and can be enabled or disabled, depending on whether transferred data is already compressed. The high-speed, low-latency hardware mode provides wire-speed, full duplex compression on networks supporting gigabit connectivity. The same compression capabilities apply to Brocade platform ATM network interfaces. Reports generated by management software demonstrate the success of a chosen compression method.

PAYLOAD MATCHING

When extending FC, ESCON, FICON, and bus and tag connectivity over Ethernet, the conversion of data blocks for transmission over the IP network can introduce inefficiencies that waste bandwidth. For example, the 2000-byte long frames received from an FC storage network do not translate well to the 1500-byte long packets typically transmitted over an IP link. Under normal circumstances, two Ethernet packets are required to carry the payload from a single FC frame. And because the two Ethernet packets are not fully utilized, 60 percent of the network’s carrying capacity is wasted. The payload-matching capabilities of the Brocade platform apply data buffering and blocking techniques to maximize the Ethernet link payload capacity and optimize the use of network bandwidth. The payload-matching process treats the frames from a given session as a single data stream. Before mapping the stream to Ethernet packets, the information is blocked into buffers. It is then compressed and packaged for outbound transmission using the IP Maximum Transmission Unit (MTU)—the Ethernet frame size. This process reduces network traffic by ensuring that each Ethernet packet carries the optimum amount of data.

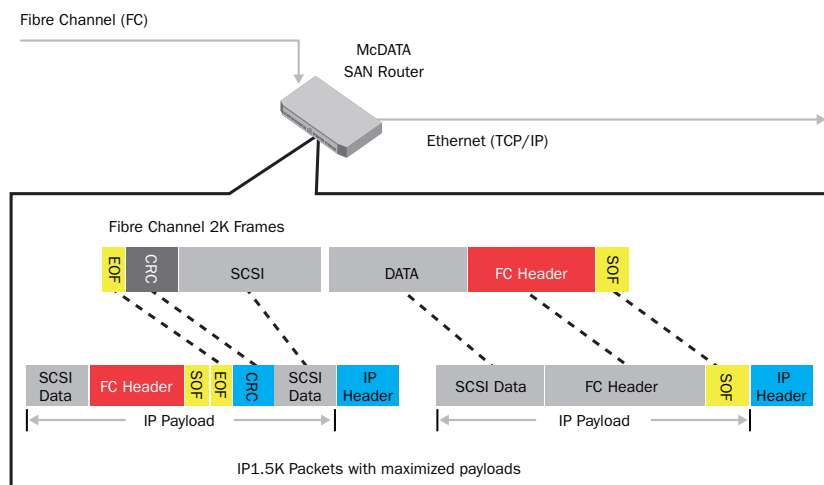

Figure 4. Payload matching between FC and IP frames

ELIMINATE UNNECESSARY FC NETWORK TRAFFIC WITH FASTWRITE

The McDATA UltraNet platform also employs a patent-pending FastWrite capability that allows wire-speed gigabit performance to be maintained over any distance. The SCSI protocol at the heart of all FC network communications was initially designed with the assumption that the host and storage would be in close proximity to each other. When performing write operations the SCSI host and storage send multiple handshakes and acknowledgments back and forth to ensure the integrity of the data transfer. However, with today’s storage networks capable of spanning hundreds, if not thousands, of miles, the complex series SCSI handshakes and acknowledgments introduce unnecessary network traffic and unwanted network latency.

The Brocade SAN Router platform also employs a patent-pending FastWrite capability that allows wire-speed gigabit performance to be maintained over any distance. The SCSI protocol at the heart of all FC network communications was initially designed with the assumption that the host and storage would be in close proximity to each other. When performing write operations, the SCSI host and storage send multiple handshakes and acknowledgments back and forth to ensure the integrity of the data transfer. However, with today’s storage networks capable of spanning hundreds, if not thousands, of miles, the complex series of SCSI handshakes and acknowledgments introduce unnecessary network traffic and unwanted network latency.

FastWrite eliminates much of the time-consuming back and forth communication in a traditional SCSI write operation. Implemented in the hardware of the Brocade platform’s intelligent ports, FastWrite reduces unnecessary confirmation round trips to speed network communications. When a SCSI write operation is detected, the two Brocade platforms bridging the extended IP or ATM network mimic the recipient and sender of the SCSI commands. The bandwidth consuming handshakes and acknowledgments, which would otherwise be passed across the WAN, are performed locally, with only the data and final command completion message passing over the wide area network infrastructure. FastWrite processing significantly speeds communications and eliminates a major source of network traffic and latency, even when only a short distance separates the two devices.

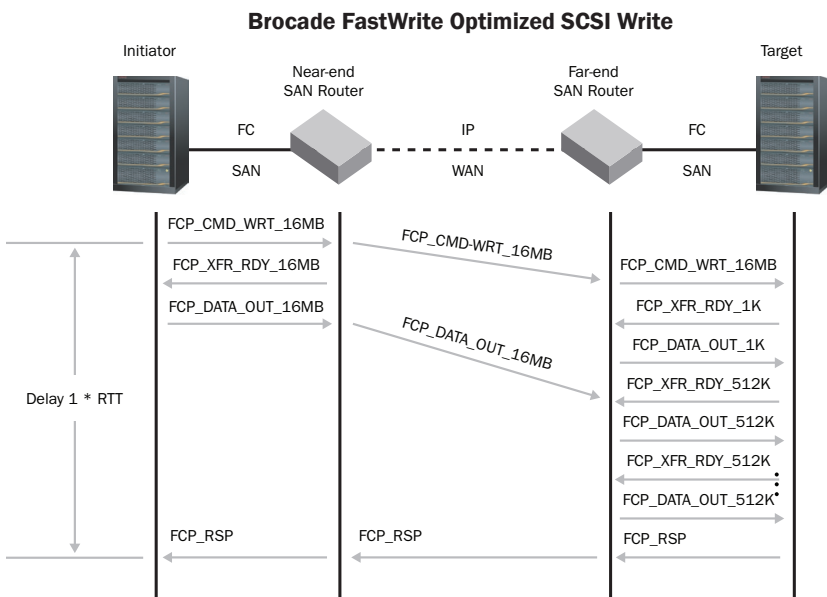

Figure 5. Brocade FastWrite capability in action

OVERCOMING CHANNEL DROOP WITH FICON EMULATION

FICON is an upper-level protocol of the Fibre Channel architecture and was developed by IBM to address various limitations in the ESCON protocol. Like SCSI, ESCON performs a complex series of back-and-forth communications between the host channel and a storage device to ensure data integrity. At distances beyond 20 km, the handshake traffic causes ESCON to experience a phenomenon known as “ESCON droop,” characterized by a substantial drop in the effective data transmission rate. Although FICON eliminates much of the redundant back-and-forth handshake

traffic of ESCON communications, speed of light, physical link, data rate, and buffer capacity factors combine to create FICON droop at distances beyond 120 km. Overcoming FICON droop for long-distance SAN extension requires complex emulation of the channel, control unit, and devices in the network.

The FICON protocol manages the physical buffers that move data across a FICON channel using a logical flow control method, called Information Unit (IU) pacing. Using buffer-to-buffer credits, IU pacing controls how much data is sent to a device before it must send an acknowledgement of receipt. As the distance between the host and device increases, packets take longer to reach their destination, and the interval between data being sent and an acknowledgement being received increases. This process, called buffer credit starvation, limits the carrying capacity of the network, regardless of how much bandwidth is actually available.

The Brocade platform can dynamically adjust the IU pacing rate by emulating the FICON channel and control unit, allowing the distance between host and storage devices to be factored into the calculation. The Brocade platform, through its emulation of the FICON channel and control unit, can factor in the distance between the host and storage devices to dynamically adjust the IU pacing rate. By appropriately setting IU pacing, interruptions to the flow of data over the FICON channel are eliminated.

In addition, the Brocade platform performs device emulation, allowing channel programs to execute at local and remote ends of the network. The Brocade platform, through its device emulation, can execute channel programs at the local and remote ends of the network, allowing devices at each end to see the attached device as local. This eliminates IU pacing from the emulated WAN section of the channel. With emulation techniques specifically designed for IBM XRC data flows, the Brocade platform can significantly reduce the number of WAN round-trip transmissions, protect the integrity of transaction data, and keep the extended FICON channel busy doing useful work.

But how does this work in a real network? The following sections of this paper will describe two case studies illustrating the power and flexibility of Hitachi and Brocade solution to solve customer issues.

CASE STUDY 1

Around the Clock Customer Service for TIAA-CREF

The financial services giant TIAA-CREF (Teachers Insurance and Annuity Association-College Retirement Equities Fund) manages more than \$290 billion in assets, representing retirement and other types of accounts for teachers, researchers, and employees of non-profit organizations. Like other financial services firms, TIAA-CREF has been expanding offerings for its account holders. In response to customer demand, TIAA-CREF executives decided they needed to provide 24/7 access to the customer service center. This business decision put the IT group in a difficult situation.

Like many IT groups, TIAA-CREF system administrators had been making use of weekend hours to perform data center maintenance and backups. However, the business demand for continuous availability forced them to rethink their backup and maintenance procedures.

With mainframes and storage systems from Hitachi Data Systems already in place, TIAA-CREF IT managers turned to Hitachi Data Systems and Brocade for help developing a business continuity strategy to ensure continuous availability of the organization's New York and Denver data centers. Using the disk mirroring capabilities of the Hitachi Compatible Replication software for IBM XRC and the storage networking extension functionality of the Brocade SAN Routers, TIAA-CREF put in place a scheduled site switching capability between the two data centers. The joint solution allowed TIAA-CREF to leverage their disaster recovery and backup site while saving money and resources.

Long-Distance Tape Pipelining

For applications with recovery time and recovery point objectives that fall below the threshold for data replication, tape-based backup and recovery processing continues to be the most cost-effective business continuity planning choice. Tape backups have traditionally provided the core of many business continuity efforts, but tape-based technology has significant drawbacks.

Because tapes need to be physically transported off-site and deposited at a remote data center or vaulting facility, the possibility of manual error is ever present. Tapes can be lost and damaged in transit, or simply missed by operators creating a pick list. Errors in vaulting tapes off-site often go unnoticed until the data is needed during a test

or disaster event. Electronic vaulting of backup data eliminates the possibility of manual tape transport errors and provides a significant improvement in disaster recovery success.

Electronic vaulting of tape involves writing backup data directly to a tape drive or library at a remote data center or vaulting facility. The ability to write to tapes that are already located remotely eliminates many of the problems that arise from shipping physical tapes offsite.

For successful electronic vaulting of backup data, remote tape drives and libraries must appear as if they are locally connected to the mainframe server in the primary data center. The extended ESCON and FICON connectivity of the Brocade SAN Router platform provides support for remote tape backup over any IP and ATM long distance network. Hardware-based compression routines and patented tape pipelining technology speed the backup process and make remote tapes appear local. The extended storage networking capabilities of the Brocade platform increase the success rate for tape-based business continuity by eliminating the possibility of manual errors in the process.

Separated by 1800 miles, the New York and Denver data centers each deployed a pair of Brocade USD-X extension systems. The USD-X systems were connected to each other over a 20MB/sec ATM circuit, and replication software from Hitachi Data Systems was installed on mainframes in both locations.

This robust configuration allows each data center to serve as a backup for the other, enabling TIAA-CREF to sustain a 7-day working week. During system upgrades, migration, and consolidation, online and batch processing are switched between the data centers to allow continuous access to customer service applications. Yearly disaster recovery tests, requiring the shutdown of each data center and involving eight transfers of production operations between the two mainframes, have worked flawlessly.

For TIAA-CREF and other joint customers of Hitachi Data Systems and Brocade, the ability to maintain 24/7 access to production applications is no longer simply an IT strategy: it has become a business imperative. Allowing customers access to financial services information whenever they need it ensures TIAA-CREF competitive advantage and safeguards its place in the global marketplace.

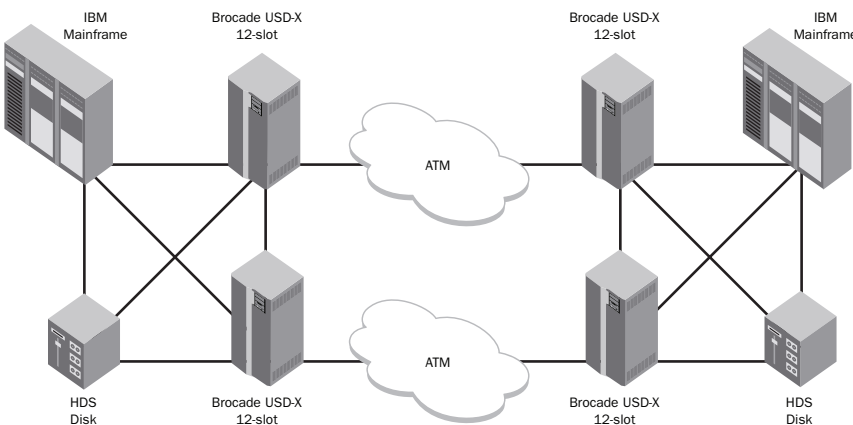

Figure 6. TIAA-CREF disk mirroring configuration

CASE STUDY 2

Data Protection and Compliance for a Large Financial Institution

Today's financial institutions have responsibilities that extend beyond their immediate customer base. With deeply interconnected global financial markets, adverse conditions for one organization can ripple through the system and affect many other players. For this reason, international and government regulatory agencies, in addition to market analysts and customers, have begun to pay close attention to how well financial organizations take care of their data assets. The need to protect critical customer data against unexpected loss led one of the largest financial institutions in the United States to implement a long-distance mirroring solution. With a mixed mainframe and open systems server infrastructure, and ESCON and FC connected storage, the organization needed a foolproof recovery solution that supported multiple protocols and worked with a heterogeneous infrastructure. The solution deployed allowed the organization to safeguard critical data assets and stay in compliance with regulatory demands.

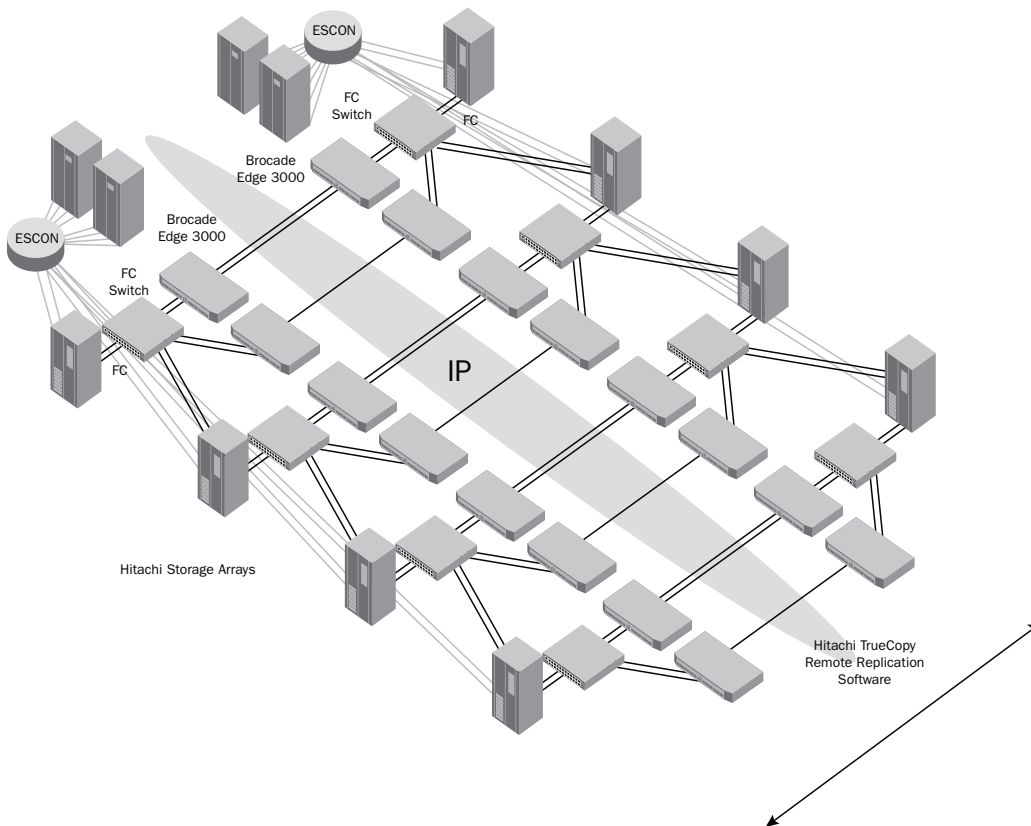

Figure 7. Schematic representing 1/4 of the infrastructure configuration for a very large Brocade and Hitachi Data Systems replication configuration

The configuration the financial organization selected is one of the largest Hitachi TrueCopy Remote Replication software implementations to date. The solution employs 32 Brocade Edge M3000 extension units in a cross-coupled, fully redundant configuration. The Brocade platforms transmit replication traffic between data centers in Kansas and Texas, over an IP network using FCIP protocol.

The joint Brocade and Hitachi Data Systems solution provides storage controller-based real-time mirroring, eliminating the effects of replication on application host servers. Use of the FCIP protocol allows the existing IP network infrastructure to be leveraged for replication traffic. This implementation has reduced deployment time, eliminated additional training of administration staff, and allowed existing network management tools to be used. Using the existing IP infrastructure for long-distance replication has also minimized the cost of business continuity planning and provided plenty of scope for future bandwidth growth.

Effective Long-Distance Data Replication

For the critical mainframe applications of the enterprise data center, data replication remains an obvious first choice when planning for business continuity. Only data replication can ensure minimal loss of data and the fast restart of applications after an unplanned system outage. However, successfully navigating the complex combination of mainframe, storage, and WAN protocols and technologies separating local and remote data centers is an immense challenge.

Brocade and Hitachi Data Systems dramatically simplify the process of long-distance mainframe data replication. Offering multiple approaches that support all storage and networking protocols typically found in mainframe environments, and providing innovative virtualization technology that masks the underlying complexity of the IT infrastructure, Brocade and Hitachi Data Systems deliver the solutions for high-performance, cost-effective, long-distance data replication. Together, Brocade and Hitachi Data Systems provide a seamless, fully integrated business continuity solution for enterprise data center applications that exceed the standards of even the most discerning customers.

Corporate Headquarters

San Jose, CA USA
T: (408) 333-8000
info@brocade.com

European Headquarters

Geneva, Switzerland
T: +41 22 799 56 40
emea-info@brocade.com

Asia Pacific Headquarters

Singapore
T: +65-6538-4700
apac-info@brocade.com

© 2007 Brocade Communications Systems, Inc. All Rights Reserved. 09/07 PA-WP-929-00

Brocade, the Brocade B-weave logo, Fabric OS, File Lifecycle Manager, MyView, SilkWorm, and StorageX are registered trademarks and the Brocade B-wing symbol, SAN Health, and Tapestry are trademarks of Brocade Communications Systems, Inc., in the United States and/or in other countries. FICON is a registered trademark of IBM Corporation in the U.S. and other countries. All other brands, products, or service names are or may be trademarks or service marks of, and are used to identify, products or services of their respective owners.

Notice: This document is for informational purposes only and does not set forth any warranty, expressed or implied, concerning any equipment, equipment feature, or service offered or to be offered by Brocade. Brocade reserves the right to make changes to this document at any time, without notice, and assumes no responsibility for its use. This informational document describes features that may not be currently available. Contact a Brocade sales office for information on feature and product availability. Export of technical data contained in this document may require an export license from the United States government.